

Bollard Light Industry Series - GY306A



- UV proof lamp cover with sealed lamp housing
- Class II electric insulation
- Anti-glare aluminium oxide reflector
- High quality die-casting aluminium housing with electrostatic powder coating
- PC Diffuser
- High lumen output 110lm/W
- IP65 Rated for outdoor environment
- Power Voltage: 110 - 240V 50/60Hz
- Applications include gardens, lawns, parks, and commercial sites

Specifications

Colour Range	3000K/4000K/5000K/6000K
Power Consumption	10W / 14W
Product Dimensions (mm)	Ø170 * 800/1000 (L*W*H)
Lumen	1100lm/1540lm
Input Voltage	AC 100-240V
Beam angle	360°
CRI	>80
Power Factor	>0.95
LED	COB
Driver	Class II Australia Certified Driver
Housing Color	Black / Grey

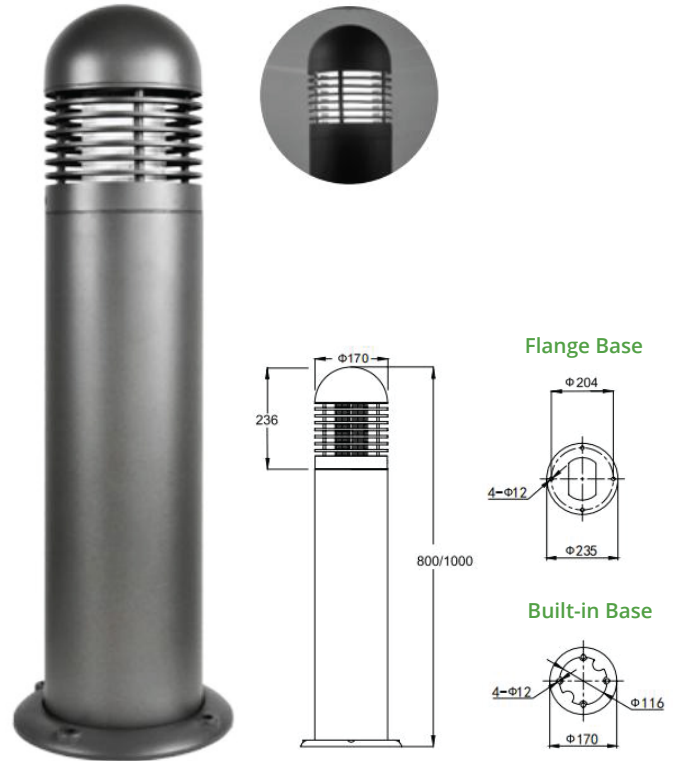

Measurement

Model	Wattage	Dimension(mm)	Lumen	CCT Colour
GYIND306A-10W-800	10W	Ø170 * 800	1100lm	3000K/4000K/5000K/6000K
GYIND306A-14W-1000	14W	Ø170 * 1000	1540lm	